

EHLEVA *smart line*





Nova >

Nova, spiral staircase composed of solid beech treads and banister with 3 spindles each tread, a guarantee for children's safety. PVC handrail timber effect available in the same tread's colour. Adjustable stair height with universal landing to be fitted to wells of any shape: round, square or for mezzanine floors. The staircase has an adjustable riser suitable to any environment. The staircase's rotation, clockwise or anticlockwise can be decided during the installation.



10 working days



Project



i
3740mm
÷
2105mm

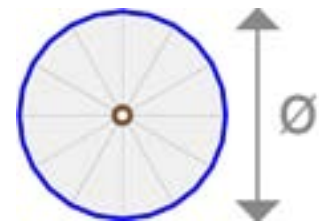

1200mm
1400mm
1600mm

Universal landing square well

Universal landing round well

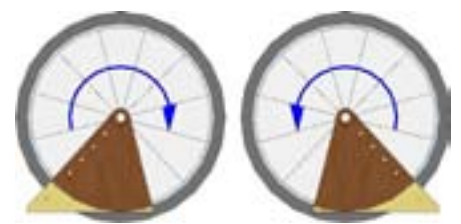
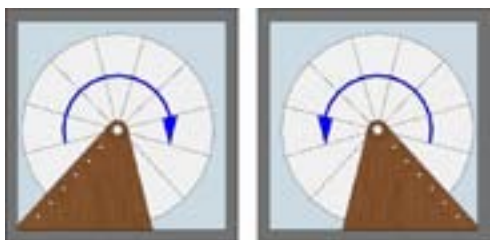

Floor protection balustrade



PVC handrail timber effect



Riser bar

Wood colour

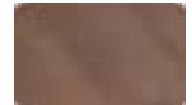

Walnut beech 252



Natural beech 253

Metal colour



90RG white



97RG grey



95RG black



Vogue >

Vogue, spiral staircase composed of solid beech treads and banister with metal spindles and stainless cables. Solid beech wood handrail . Adjustable stair height with universal landing to be fitted to wells of any shape: round, square or for mezzanine floors. The staircase has an adjustable riser suitable to any environment. The staircase's rotation, clockwise or anticlockwise can be decided during the installation.



10 working days



Project



i
3740mm
÷
2105mm

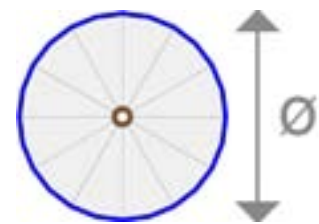

1200mm
1400mm
1600mm

Universal landing square well

Universal landing round well

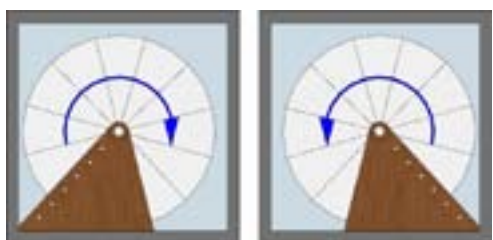

Floor protection balustrade



Wood handrail



Riser bar

Wood colour

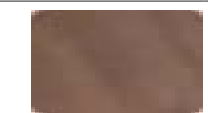

Walnut beech 252

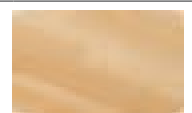

Natural beech 253

Metal colour

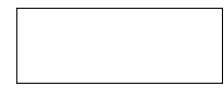

90RG white



97RG grey



95RG black



Flow

Flow, spiral staircase with Medium-Density-Fibreboard treads of white color. The banister is composed of 3 metal spindles for each tread, grey color, PVC grey handrail for better handhold. Adjustable staircase height with universal landing to be fitted to wells of any shape : round, square or for mezzanine floors. The staircase has an adjustable riser suitable to any environment. The staircase's rotation, clockwise or anticlockwise can be decided during the installation.

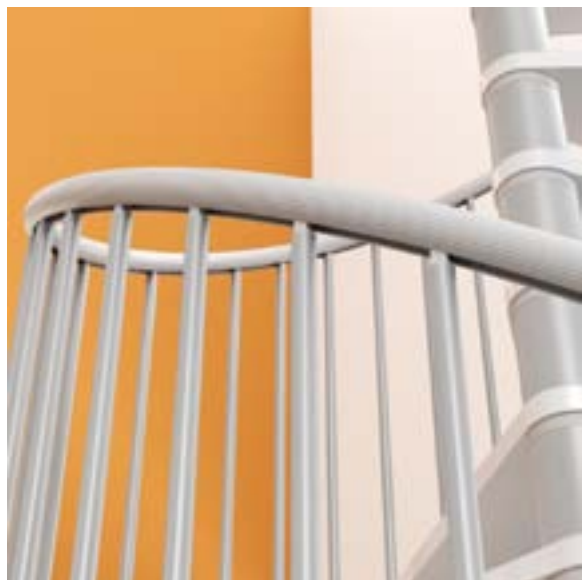

10 working days



Project



i
3740mm
÷
2105mm

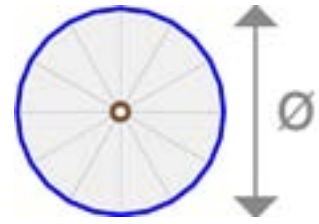

1200mm
1400mm
1600mm

Universal landing square well

Universal landing round well

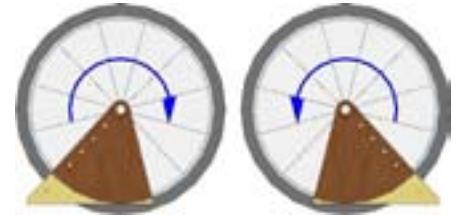
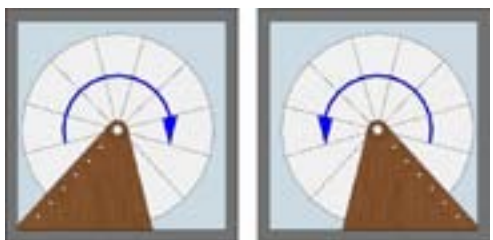

Floor protection balustrade



PVC grey handrail



Riser bar

Wood colour



Medium-Density-Fibreboard white

Metal colour



97RG grey



Flow Q

Flow Q, spiral staircase for square well with Medium-Density-Fibreboard treads of white color. The banister is composed of metal grey spindles with a space between them lower than 10 cm, PVC grey handrail for a better handhold. Adjustable staircase height with universal landing to be fitted to wells of any shape : round, square or for mezzanine floors. The staircase has an adjustable riser suitable to any environment. The staircase's rotation, clockwise or anticlockwise can be decided during the installation.

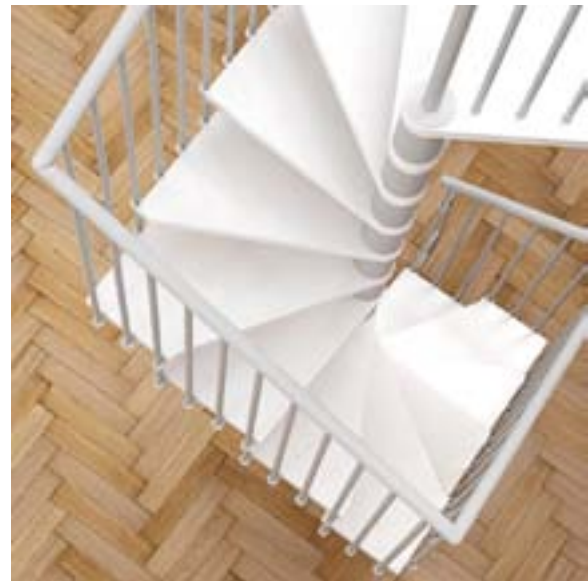
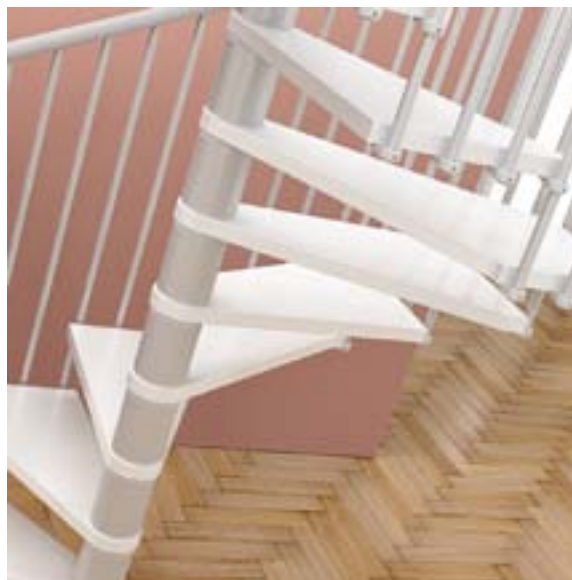
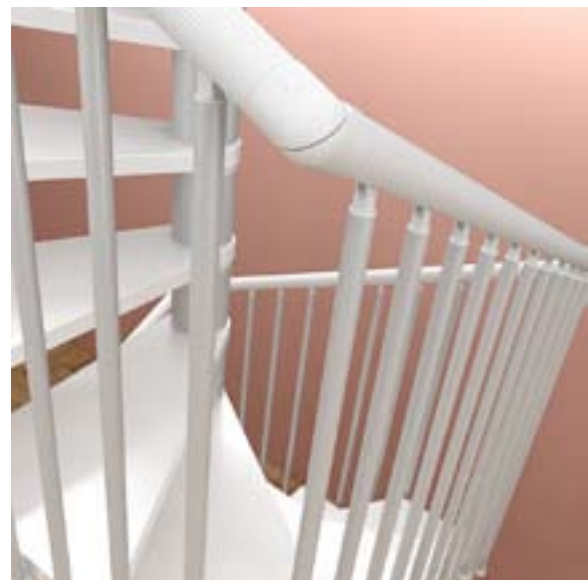

10 working days



Project



i
3740mm
÷
2105mm

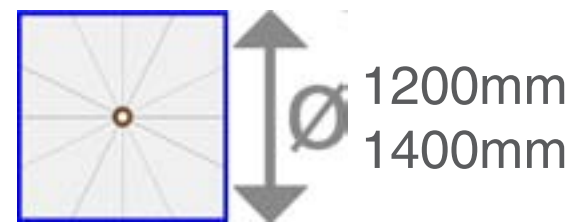

Universal landing square well

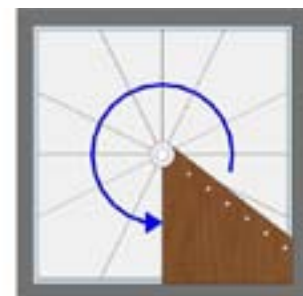
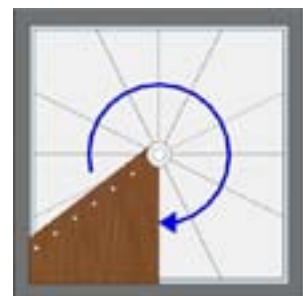

Floor protection balustrade



PVC grey handrail



Riser bar

Wood colour



Medium-Density-Fibreboard white

Metal colour



97RG grey



Motion >

Motion, a steel and painted staircase with high resistance varnishes, PVC handrail for a better handhold. PCV cover treads for high resistance against wear and its banister composed of 3 spindles each tread is a guarantee for children's safety. Adjustable stair height with universal landing to be fitted to wells of any shape: round, square or for mezzanine floors. The staircase has an adjustable riser suitable to any environment. The staircase's rotation, clockwise or anticlockwise can be decided during the installation.

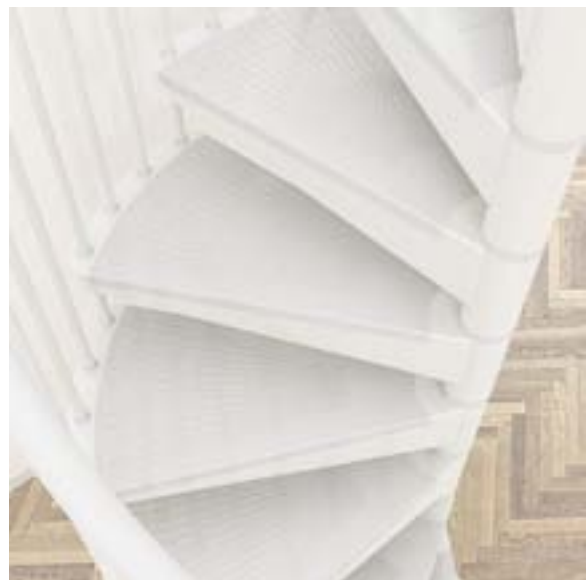

10 working days



Project

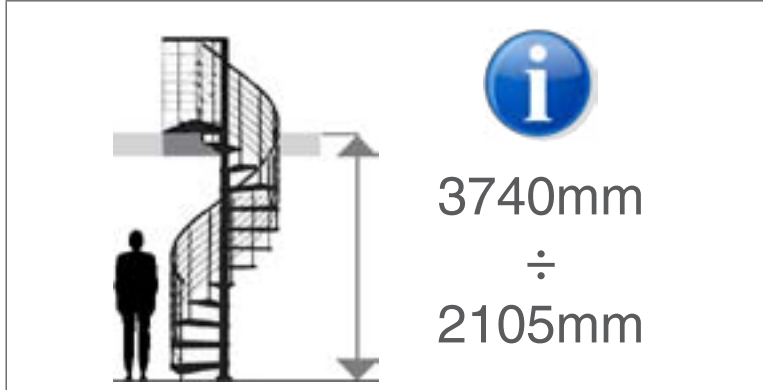

Universal landing square well

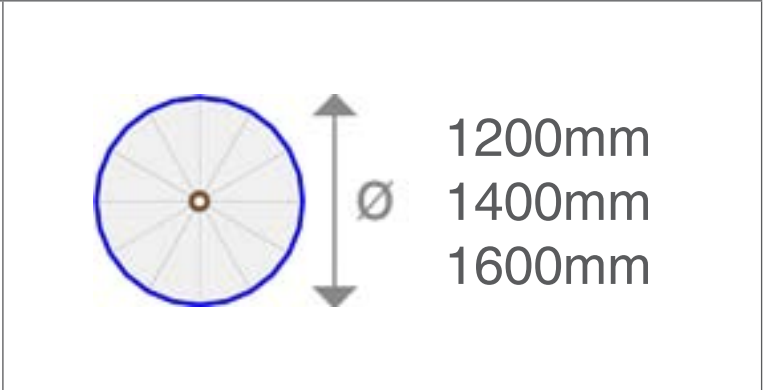
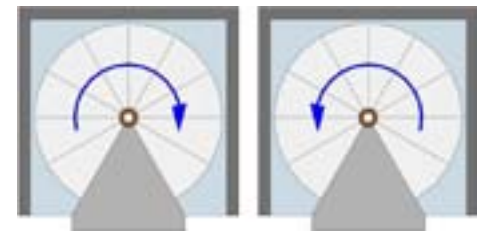

Universal landing round well

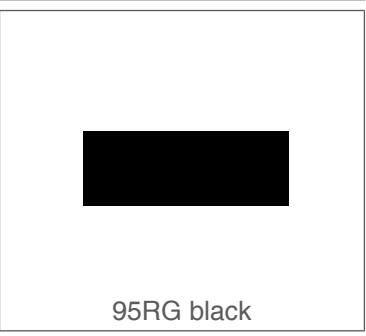
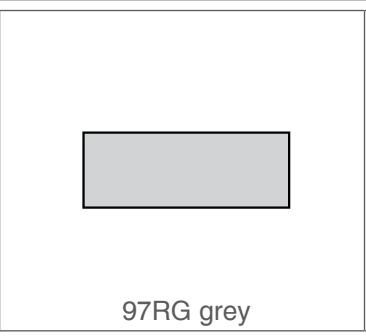
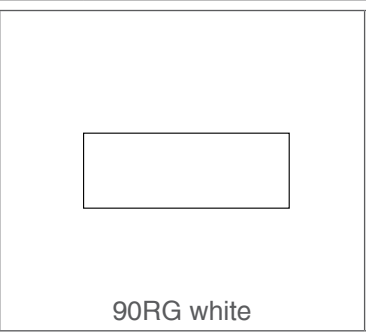
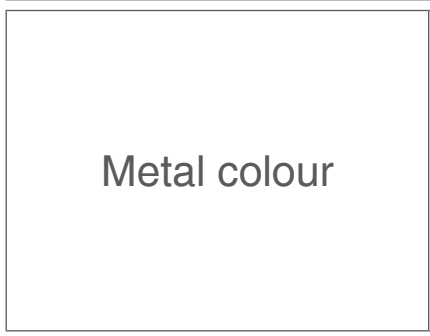
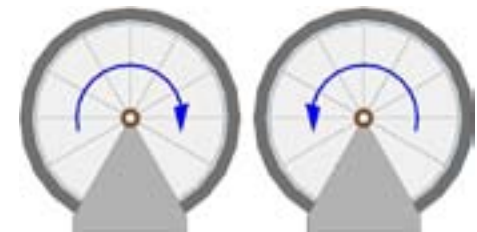



Vector >

VECTOR modular staircases are realized with steel modules, the banister is composed of metal spindles and stainless cables. Standard widths: 700mm and 830mm. The treads with thickness of 40mm and the round handrail of diameter 45mm are made of painted solid beech wood. Adjustable stair during the fitting and suitable to wells of any shape. The staircase has an adjustable riser and tread suitable to any environment. The staircase's rotation, clockwise or anticlockwise can be decided during the installation.



10 working days



Project

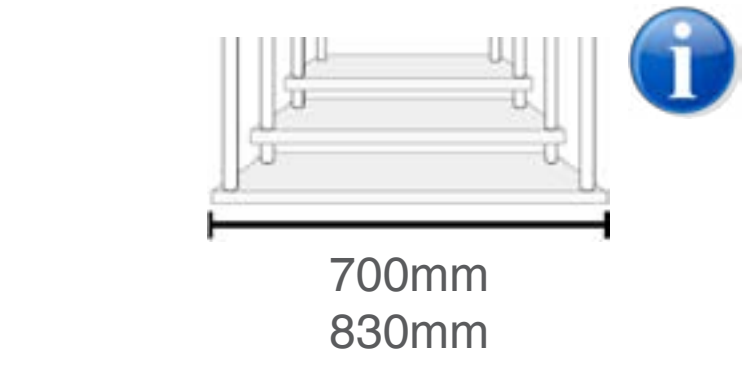

Available shapes			Useful width	
			P=700mm ; 830mm	P=700mm ; 830mm



Wood colour	 Walnut beech 252	 Natural Beech 253	
Metal colour	 90RG white	 97RG grey	 95RG black



Stilo >

STILO modular staircases are composed of modules and steel banister (2 spindles each tread). Standard widths: 700mm and 830mm. The treads with thickness of 40mm and the round handrail of diameter 45mm are made of painted solid beech wood. Adjustable stair during the fitting and suitable to wells of any shape. The staircase has an adjustable riser and tread suitable to any environment. The staircase's rotation, clockwise or anticlockwise can be decided during the installation.

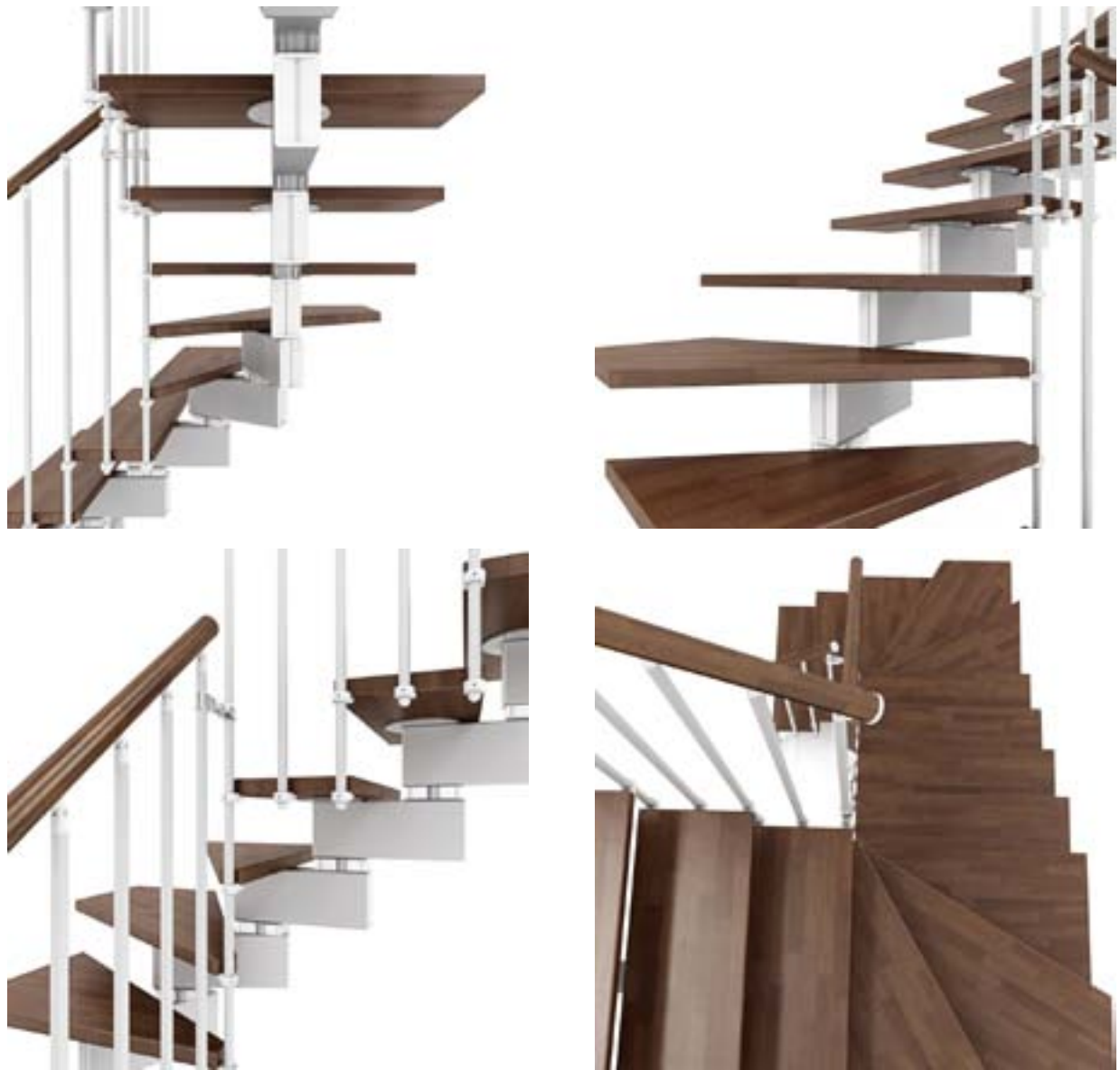

10 working days



Project

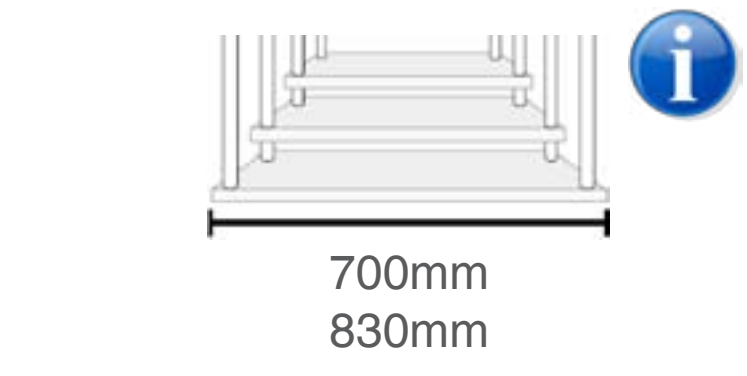
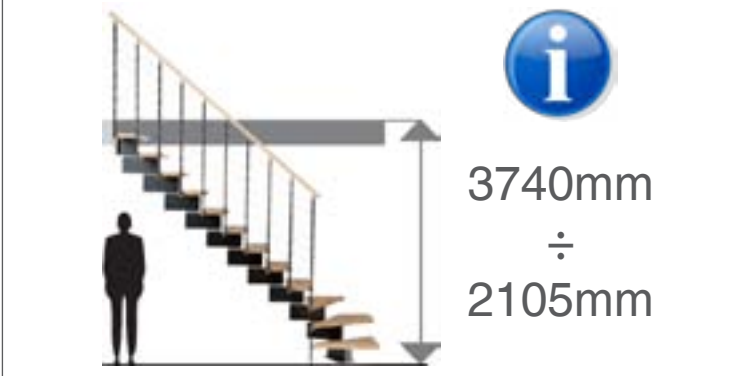

Available shapes			Useful width	
			P=700mm ; 830mm	P=700mm ; 830mm

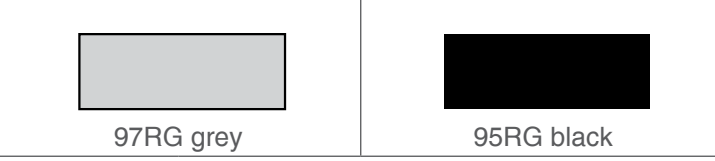
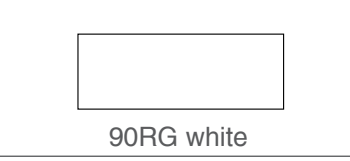
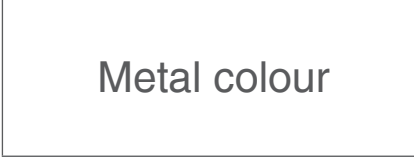
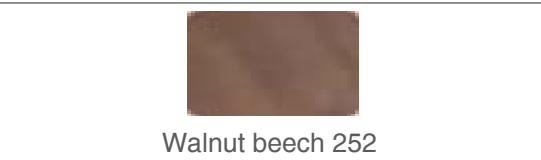
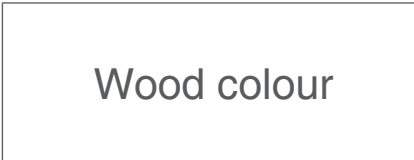



Jack >

The **Jack color** modular staircases for internal use are realized with steel painted modules, treads and banister.

The handrail of diameter 45 mm is made of PVC for a better handhold. This stair is available in the following standard widths: 800mm and 900mm. The steel treads are 6mm thick and supplied with an adhesive strip to grant an high security level. Jack has an easy adjustment system that allows it adaptable to any measure.

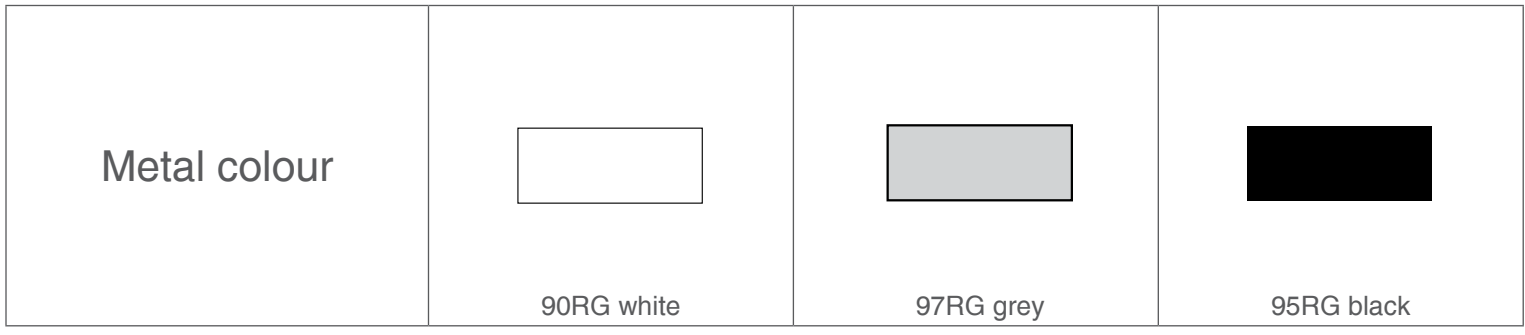
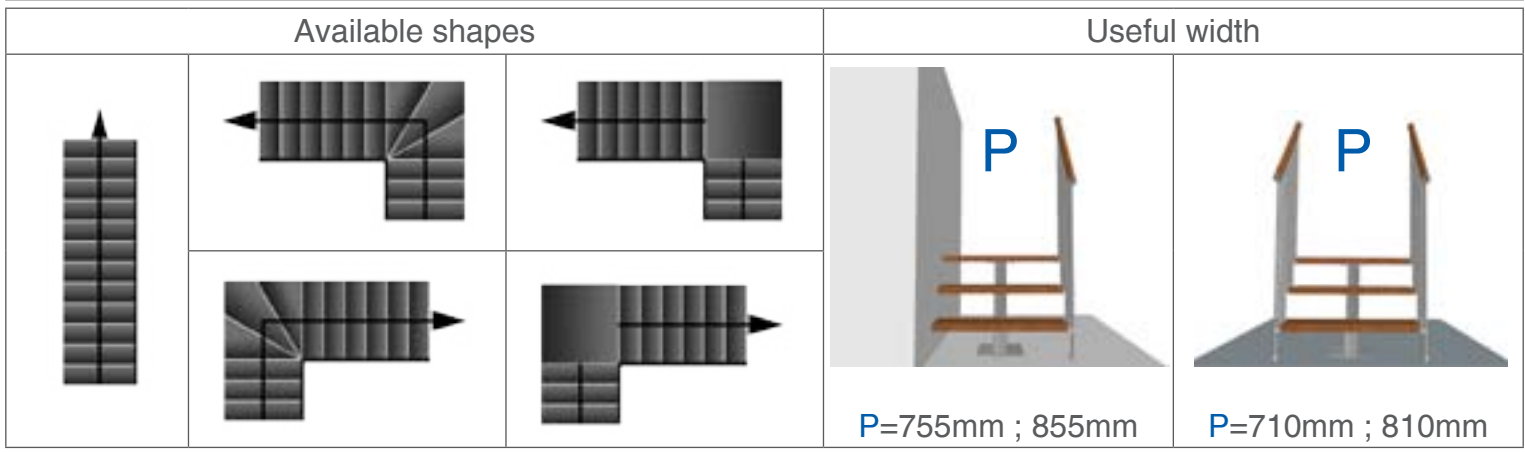
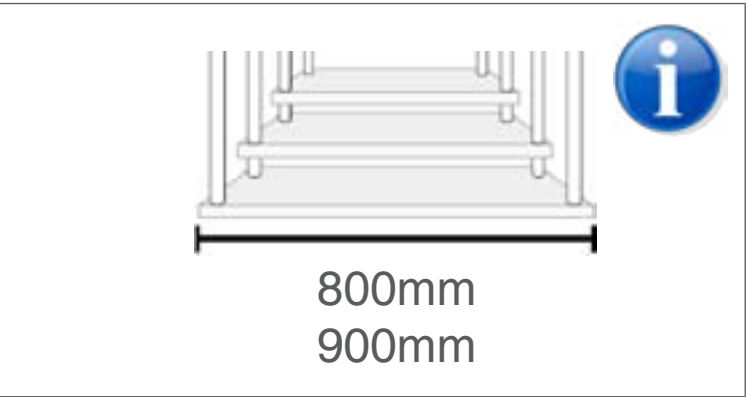
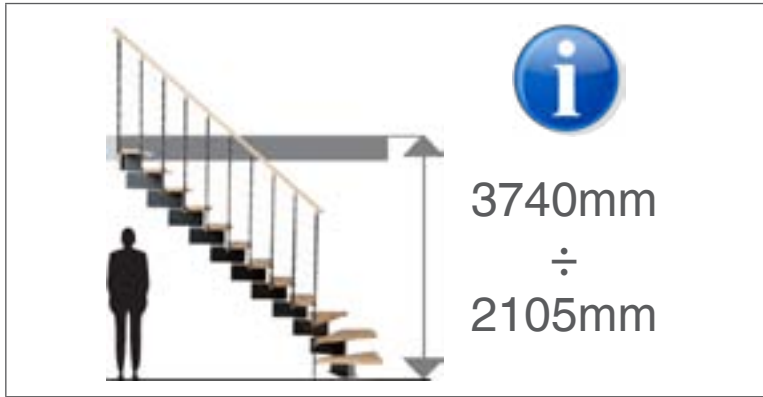

Venus >



Venus, space saver staircase with alternating treads is composed of steel modules and steel spindles banister. The treads of thickness 40 mm are made of painted solid beech. PVC handrail for a better handhold, adjustable stair height during the installation. The staircase has an adjustable riser and tread (P) suitable to any environment. The staircase's rotation, clockwise or anticlockwise can be decided during the installation.



10 working days



Project

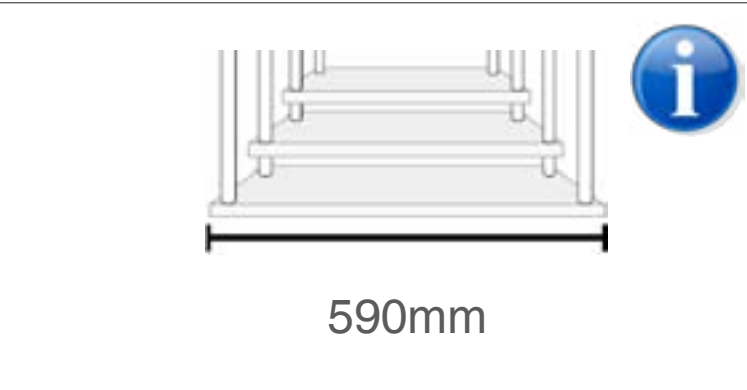
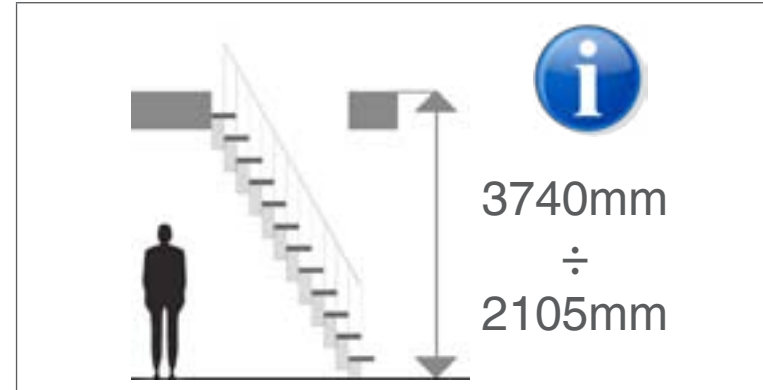

Available shapes

Useful width

P=545

P=545mm

Floor protection balustrade

External banister

Wood colour

Walnut beech 252

Natural beech 253

Metal colour

90RG white

97RG grey

95RG black

Magic >



Magic, spiral staircase with Medium-Density-Fibreboard treads, banister composed of metal painted spindles and stainless cables. PVC handrail for a better handhold. Adjustable stair height permits to adapt it directly on site according to well measures. The space saver stair is the ideal solution for small spaces offering a modern and contemporary design. The shape of the tread allows to save the space granting an optimal walkover surface. The staircase has an adjustable riser suitable to any environment.



10 working days



Project



i
3740mm
÷
2105mm

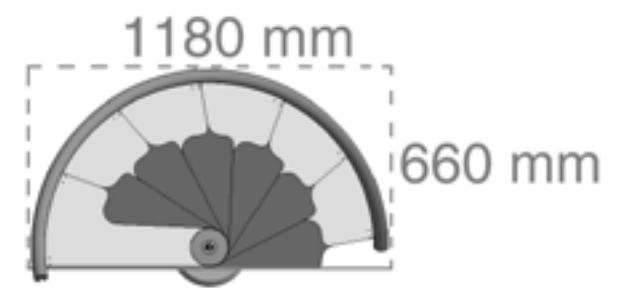

Alternate treads and rotation



Floor protection balustrade



PVC grey handrail

Treads colour



white



black and white



black



Jack zin

The **Jack zin** modular staircases for external use are realized with hot galvanized steel modules, treads and banister.

The handrail of diameter 45 mm is made of PVC for a better handhold. This stair is available in the following standard widths: 800mm and 900mm. The steel treads are 6mm thick and supplied with an adhesive strip to grant an high security level. Jack zin has an easy adjustment system that allows it adaptable to any measure.

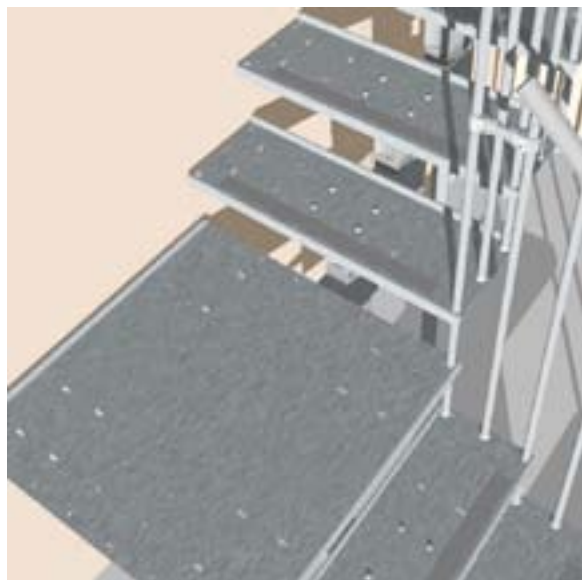

20 working days



Project

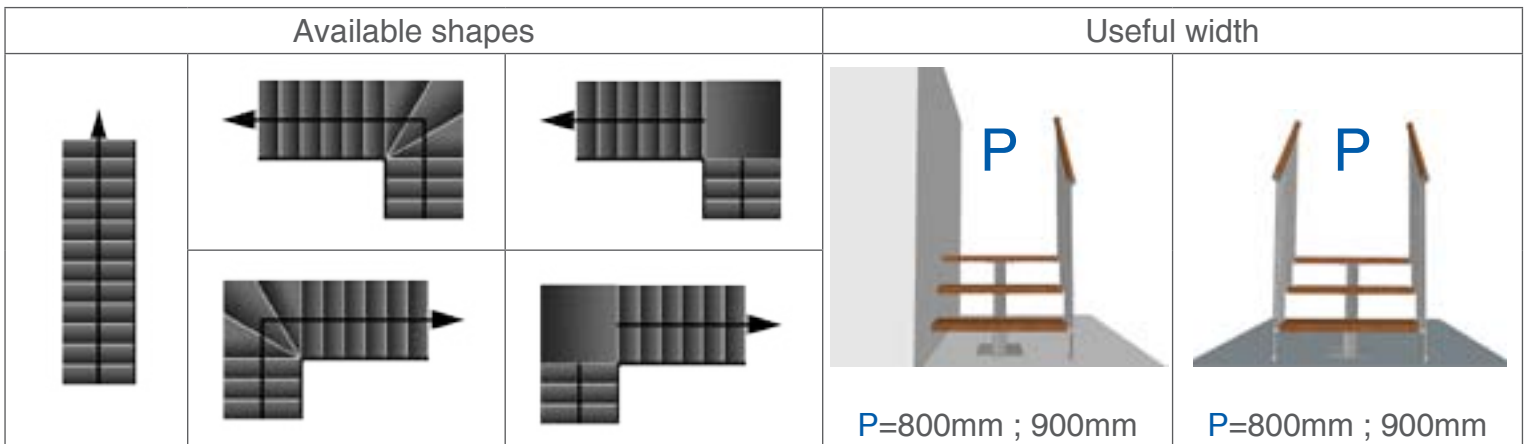
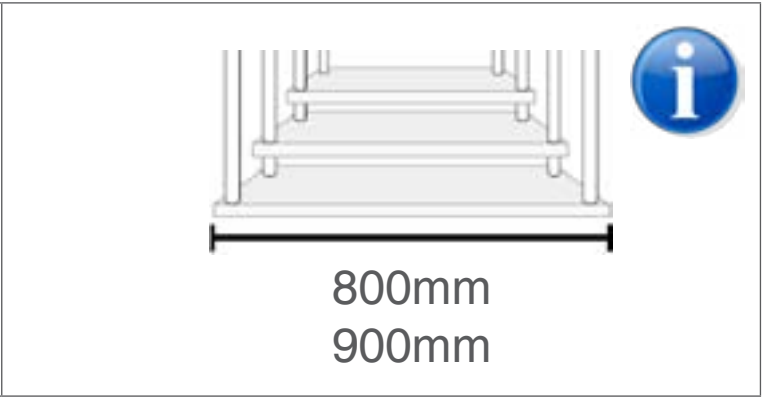
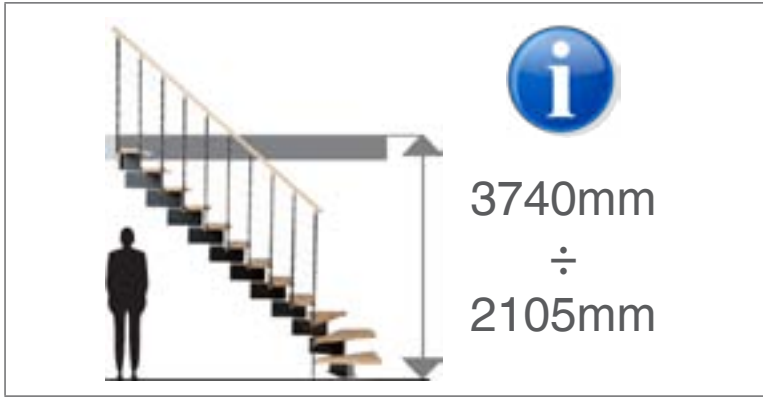

Jack zin Metal treatment	 galvanization's treatment		
Jack zincolor Metal colour	 90RG white	 97RG grey	 95RG black
galvanization's treatment + painted			



Optima

Optima, a steel spiral staircase treated through liquid zinc immersion at 800°; this process makes the product resistant to atmospheric agents. PVC handrail for a better handhold. The banister composed of 3 spindles each tread is a guarantee for children's safety. Adjustable stair height with universal landing to be fitted to wells of any shape: round, square or for mezzanine floors. The staircase has an adjustable riser suitable to any environment. The staircase's rotation, clockwise or anticlockwise can be decided during the installation.



10 working days



Project

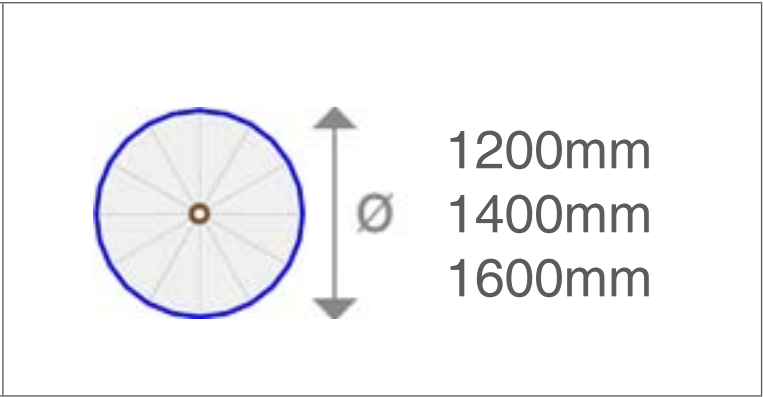
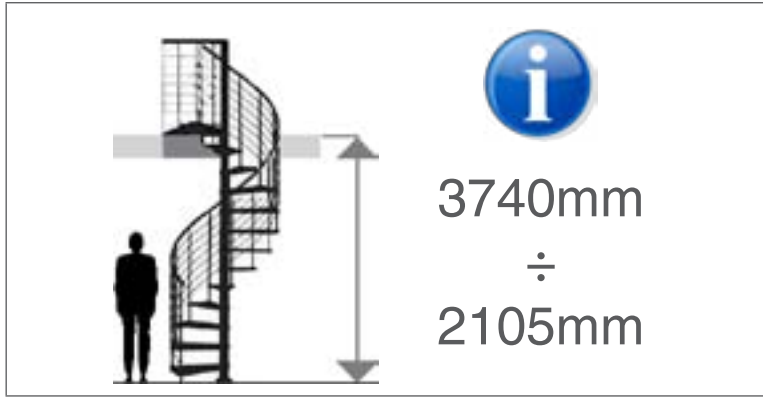

Universal landing square well

Universal landing round well

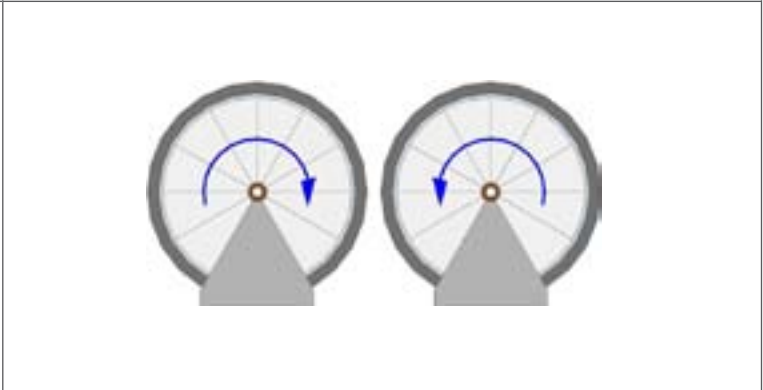
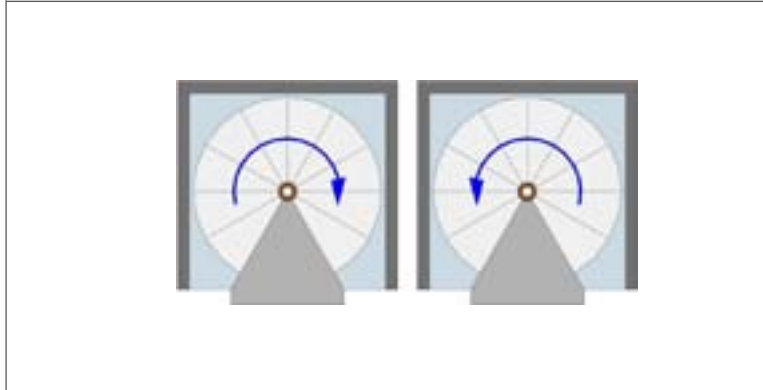

Metal treatment



EHLEVA *smart line*

www.ehleva.com



Mobiolo S.p.A. P.IVA 02620340352
Strada Cristoforo Colombo, 22/B
42046 Reggio (RE) Italy
Tel. +39 0522 211 811
Fax +39 0522 973 139
www.mobiolo.com
e-mail: mobiolo@mobiolo.it

Export Department
Tel. +39 0522 211 812
Tel. +39 0522 211 836
www.mobiolo.com
e-mail: export2@mobiolo.it